

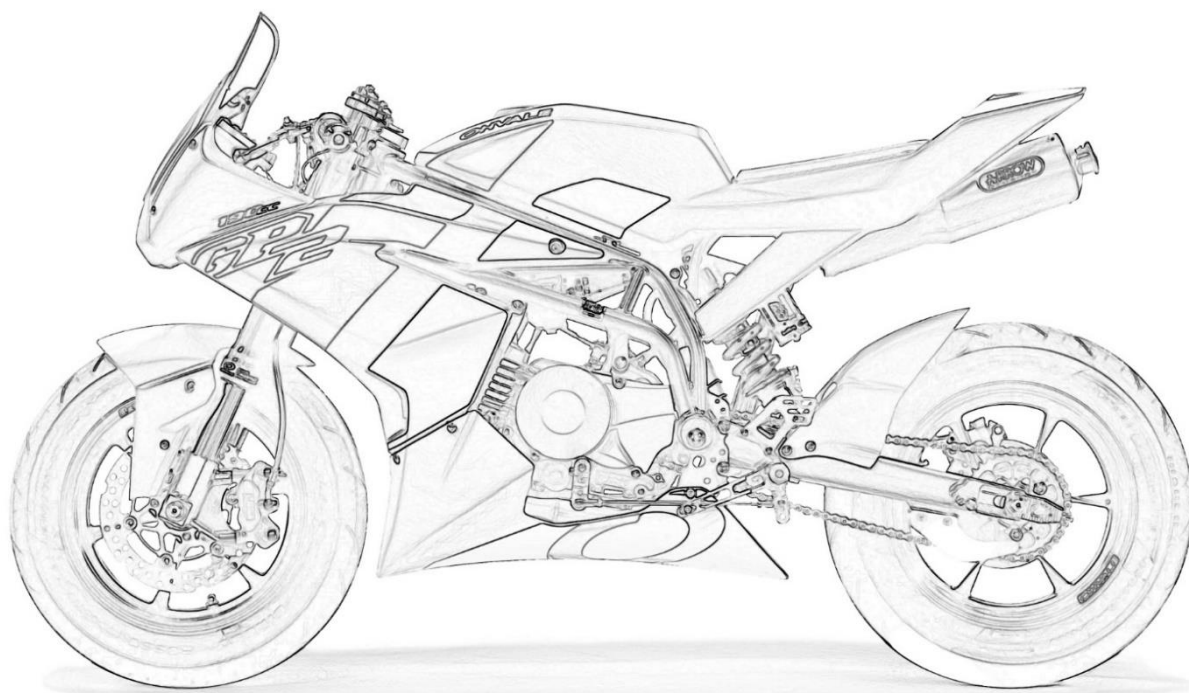

BEFORE STARTING
Use & Maintenance



GP-1

GP-2

This manual must be considered as an integral part of the vehicle and includes the most up-to-date information at the time of going to print. Ohvale S.r.l. therefore reserves the right to make changes of any kind to this manual at any time without notice and without any obligation in this regard.

This manual may not be reproduced, in whole or in part, without the express written authorization of Ohvale S.r.l.

The vehicle reproduced in this manual may differ from the vehicle owned.

1. WARNINGS

Using the motorcycle safely is an important responsibility. One of the purposes of this manual is to inform about the possible risks that is possible to incur with an incorrect use of the vehicle. Therefore, in order to guarantee safety and driving pleasure, it is expressly recommended to: (i) read this manual carefully; (ii) strictly follow the recommendations contained in this manual; (iii) pay attention to the messages contained in this manual, as well as on the vehicle; (vi) take the time necessary to practice with the vehicle in safe places in order to understand its operation and get used to overall dimensions and weights.



The maximum technically permissible load on the bike is 110 Kg.

The transport of passengers or luggage is prohibited. Excessive loads, as well as the transport of passengers or luggage, can cause accidents resulting in serious injury or death.



The vehicle is not approved for road use and it is forbidden to use it on public roads. The GP-0 / GP-2 motorcycle can only be used in suitable facilities or private areas equipped for the use of this type of vehicle. In any case, it is recommended that you never drive the vehicle beyond your capacity or faster than the conditions of the road allows.



Always wear appropriate personal protective clothing, an approved full-face helmet, full leather suit, boots, gloves and approved back protector before using the vehicle. The use of helmets and approved protective clothing helps to significantly reduce the number and severity of injuries to the head and other parts of the body.



Make sure you are in perfect psycho-physical health and that you are not under the influence of alcohol and / or drugs. Even only one alcoholic drink can reduce reaction time and the ability to react to changing conditions.



Make sure that the vehicle is subject to proper and constant maintenance in order to ensure that it is always in condition to be driven safely. In particular, it is recommended to check the condition of the vehicle and its components before each ride and carry out at least all the maintenance recommended in this manual. Improper vehicle maintenance can cause accidents resulting in serious injury or death. It is expressly not recommended to install accessories that can make the vehicle dangerous, as well as the use of non-original spare parts and accessories (i.e. not designed by Ohvale Srl), as well as making changes of any kind to the vehicle that alter its original project. This could compromise the safety of the vehicle (which could cause accidents resulting in serious injury or death), as well as voiding the warranty.



Be sure to use the vehicle's engine in non-enclosed or partially enclosed areas as the exhaust gases contain carbon monoxide, a colorless and odorless gas which inhalation can cause unconsciousness and even death. It is therefore recommended to start the vehicle engine only in open and well-ventilated areas.

2. HALF-HANDLEBAR POSITION

Fixing of the half-handlebars:

- In the case of half-handlebar bracelets as in fig. A, lay them against the upper steering plate and hold them in position manually.
- Insert the half-handlebar inside the seat of the bracelet and rotate it until obtaining the ideal position for rider's ergonomics.
- Tighten the fixing screw of the half-handlebars indicated by the arrow. (tightening torque max 22 Nm)
- Repeat the operations for the other half-handlebar.



3. CHOKE – STARTING THE ENGINE

3.1. HANDLEBAR CHOKE COMMAND



Choke command is placed on the left side half-handlebar for mod. 110 Automatic, 110 4s EVO, 160 4s EVO and GP-2 190 4s.

To activate it, it is necessary to press the lever along its entire stroke according to the direction indicated in the figure and keeping it in position.

3.2. CARBURETOR CHOKE COMMAND

The choke command is present on the left-side of the carburetor. To activate it, press the lever along the direction indicated in the figure.

Mikuni 22

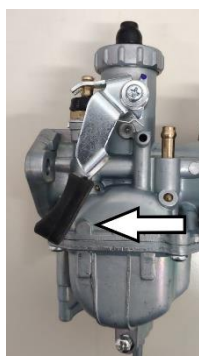

For mod. 110 4S std

ZS PZ27



For mod. 160 4S std

3.3. ENGINE START mod. 110 AUTOMATIC

To start the cold engine:

- Open the fuel taps of the tank and of the carburetor by rotating the command counter clockwise.
- Activate the choke control and hold it in position (follow the direction of the arrow in the photo).
- Set the engine kill command in ON position.
- Pull the rear brake. (hand master cylinder on the left half-handlebar).
- Push the starter button.
- Deactivate the choke command with the engine running and let it run at minimum rotation speed for a few minutes to warm it up.

 **Info** Do not use the choke command to start up the engine when it's hot.

 **Info** Do not use the throttle during start-up to avoid problems with kickback of the start lever and backfires inside the carburetor.

NOTE *If the engine doesn't start in 5 seconds, release the start button and wait 10 seconds before trying again.*

NOTE *For correct engine start-up and operation, check that the minimum rotation speed is approximately 2000 rpm.*

3.4. ENGINE START with KICK STARTER

To start the cold engine:

- Open the fuel tap by rotating the command counter clockwise.
- Activate the choke command and hold it in position as previously indicated.
- Set the shift in neutral.
- Set the engine kill command in ON position.
- Push the kick starter lever until the TDC* piston position (the effort increases). * TDC = Top Dead Centre
- Keep the lever pressed and when the effort begins to decrease, push the lever quickly and vigorously throughout its stroke.
- Deactivate the choke command with the engine running and let it run at idle speed for a few minutes to warm it up.

 **Info** Do not use the choke command to start up the engine when it's hot.

 **Info** Do not use the throttle during start-up to avoid problems with kickback of the start lever and backfires inside the carburetor.

Pay attention to the return of the starting lever. If the lever does not return to its initial position turn off the engine.

NOTE *If the engine does not start after 10 attempts, wait a few minutes and try again by deactivating the choke command.*

NOTE *For correct engine start-up and operation, check that the minimum rotation speed is approximately 2000 rpm.*

4. SHIFT LEVER

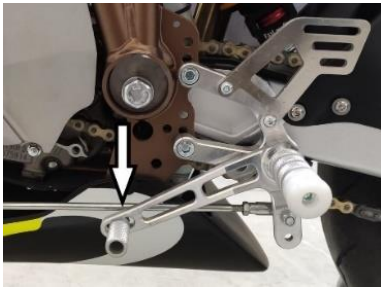

The shift lever is placed on the left side of the engine.

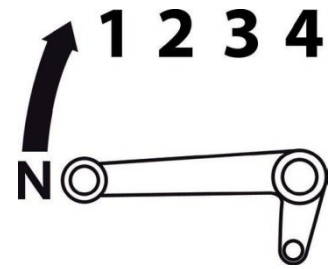

Gears positions
The neutral (N) is placed before the first gear.

4.1. REVERSE SHIFT LEVER



The shift lever is placed on the left side of the engine.

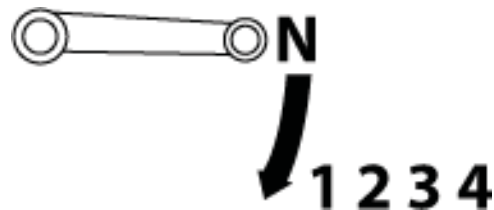

Gears positions.
The neutral (N) is placed before the first gear.

4.2. REVERSE SHIFT LEVER with LEVERAGE

GP-0 110/160 EVO e GP-2 190

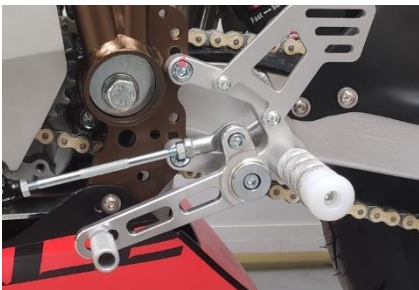

The shift lever is placed on the left side of the engine.



Gears positions.
The neutral (N) is placed before the first gear.

NOTE To avoid gearbox problems, you **MUST** partially **CLOSE** the throttle, pull the clutch lever, change gear, release the clutch lever and re-open the throttle.

5. REFUELING

To refuel:

- Place the motorbike on the rear stand.
- Turn the tank cap counterclockwise to remove it.
- Refuel, taking care not to overfill the tank causing spills.
- Insert and screw in the tank cap making sure it is properly closed.

6. ENGINE RUNNING-IN

During the first 2 hours of use, follow the instructions below to ensure future reliability and performance of the motorcycle.

- Leave the engine running at the minimum rotation speed for a few minutes before use the motorcycle.
- Avoid turning on the gas completely.
- Avoid rapid acceleration and hard braking.
- Do not exceed the specified engine performance:

Hours of use	Throttle opening
From 0 - 30 minutes.	Up to and not over 1/2.
From 30 - 90 minutes.	Up to 3/4.
From 90 - 120 minutes.	Up to 100%

NOTE

For a correct use, avoid the start of the limiter, take advantage of the torque of the engine.

After completing the running-in, it's recommended to upshift within the engine RPM ranges indicated below. If you have the **Alfano 6** dashboard (optional), it is advisable to set the switch on of the last two red LEDs for the minimum and maximum value of the ranges indicated here:

ENGINE	RANGE UPSHIFTING (RPM)
110 4S	10000 / 10200
160 4S	10000 / 10200
190 DAYTONA	10200 / 10400

7. ENGINE OIL

Use engine oil **MOTUL 300V 4T 10W40** only.



7.1. OIL QUANTITY (with engine completely empty)

ENGINE	QUANTITY (total)
110 A	1100 cc
110 4S	850 cc
160 4S	1100 cc
190 DAYTONA	1000cc

7.2. ENGINE OIL LEVEL CHECK

110 A model



- Start the engine and let it run at the minimum rotation speed for 3/5 min, then turn it off.
- After 2/3 min. place the vehicle on a flat surface in vertical position (without stand).
- Remove the filler cap placed on the right side of the engine, clean the level rod and insert it in again without screwing it.
- Remove level rod and check the level (the oil should be nearly the max marker). Eventually, add the correct amount of oil in order to restore the correct level.
- Screw the cap until it's firmly close.

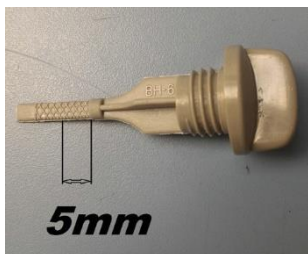

110 4S e 160 4S model

- Start the engine and let it run at the minimum rotation speed for 3/5 min, then turn it off.
- After 2/3 min. place the vehicle on a flat surface in vertical position (without stand).
- Remove the filler cap placed on the right side of the engine, clean the level rod and insert it in again screwing it in completely.
- Remove level rod and check the level (the oil should be at 5 mm [0.20 in] from max marker). Eventually, add the correct amount of oil in order to restore the correct level.
- Screw the cap until it's firmly closed.

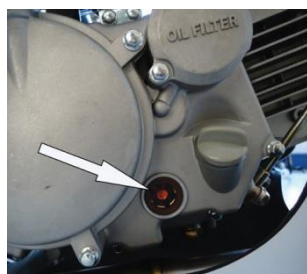

190 Daytona model

- Start the engine and let it run at the minimum rotation speed for 3/5 min, then turn it off.
- After 2/3 min. place the vehicle on a flat surface in vertical position (without stand).
- The oil level must be between the half and the top of the porthole.
- To restore the correct oil level, open filler cap placed on the right side of the engine and add the necessary quantity of oil.

NOTE *Overfilling oil or using the vehicle with insufficient oil can cause engine damage. It is recommended not to use different types of engine oil.*

8. VALVE CLEARANCE / SEAT

The valve clearance for all engines must be:

INTAKE	EXHAUST
0,10 (±0.02) mm	0,15 (± 0,02) mm
0,0039 (± 0.0008) in	0,0059 (± 0,0008) in

i **Info** Check the valve clearance when the engine is cold.

i **Info** From 2022 the 160 4s is admitted to have both Ergal valve seat.



9. SPARK PLUGS Cross reference

Engine	Thread	NGK	NGK IRIIDIUM	TORCH	DENSO	BOSCH	CHAMPION
110A 110 4S 160 4S	M10x1	CR7HSA	CR7HIX	A 7 RTC	U22FSR-L	UR3AC 0242055501	RZ 96 C PRZ 9 HC
	M10x1	CR8HSA	CR8HIX	A 8 RTC	U24FSR-U	UR2AC	RZ 94 C
190/212	M8x1	ER9EH	ER9EHIX		Y27FER		

10. CARBURETOR SETTINGS

MODEL	GP-0 110 4S	GP-0 160 4S	GP-2 190 4S
TYPE CARBURETOR	PHBL 24	PHBH 28	PHBH 28
Starting jet	60	55	55
Idle jet	40	50	50
Main jet	104	120	122
Jet needle type	D49	X71	X71
Jet needle position	3° from the top	4° from the top	3° from the top
Float	6,5g	6,5g	6,5g
Needle & Seat Assy	250	250	250
Needle Jet	264 K	262 T	262 T
Valve	55	50	50
Spring	9644	8550	8550

11. BATTERY (VERSIONE 110 A)

Characteristics:

- Lithium battery 12V – 24Wh – 140A.
- Battery with acid 12V – 6Ah – 130A.

11.1. WARNINGS

- **Do not short circuit the battery to avoid dangerous situations that can cause serious injury.**
- Charge the battery at least every six months, **the voltage must never drop below 10 V.**
- Do not charge the battery for more than 24 hours.
- Do not charge the battery using a voltage higher than 15V.
- Do not over charge or over discharge the battery.
- Do not reverse the polarity of the battery.
- Do not disassemble, deform or modify the battery.
- Keep out of reach of children.

NOTA: Carefully read the battery instruction manual supplied with the motorcycle for information regarding installation, charging process and maintenance.

It is recommended to avoid hard braking (which can reduce the stability of the vehicle), as well as to reduce the speed near curves in order to avoid the risk of falls and slips.

12. BRAKES

12.1. BRAKE FLUID LEVEL CHECK

Use only brake fluid **MOTUL RBF 660 Factory Line**.

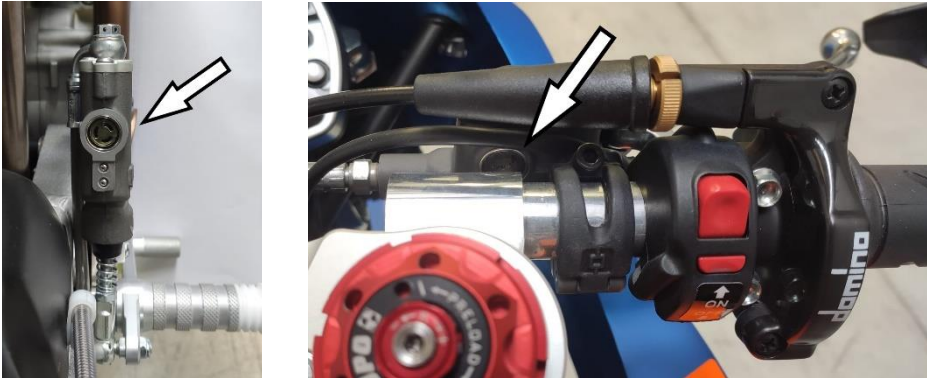

i Before each use, check the brake fluid level through the appropriate porthole located on the front and rear brake pump (see pictures).

i The brake fluid must be replaced every 2 years. Maintenance operations must be carried out by authorized personnel only.

The liquid used in the braking system is highly corrosive to painted parts and tires. Make sure that none of the parts mentioned come in contact with the liquid. Protect the fairings and other painted parts from even minimal contact with the liquid and follow all the warnings and instructions indicated in the package.

12.2. BRAKE LEVER REGULATION – JJUAN BRAKE SYSTEM

Rotate the adjustment ring to adjust the height of the brake lever.

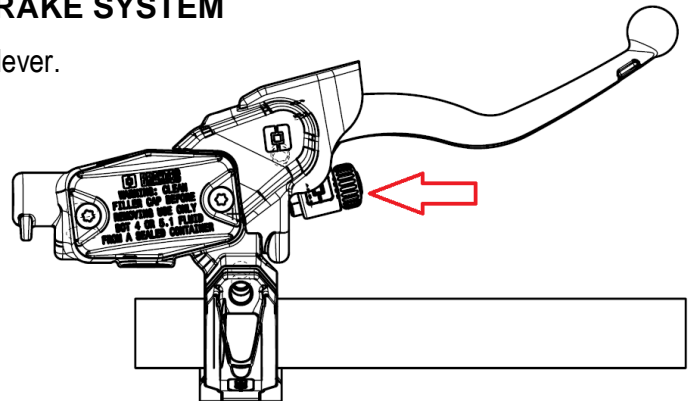

12.3. BRAKE PADS RUNNING-IN

Run in the brake pads as follows:

- Brake gently for 4-5 laps at medium speed. Avoid any thermal shock to the new pads.
- At least 90% of the pad surface must be in contact with the disc surface to consider running in completed.
- Return to the box and let the brakes cool naturally.

NOTE If possible, run in the new pads using used brake discs.



In rainy or wet conditions, the brakes tend to decrease braking efficiency. It is therefore recommended to brake with extreme care and caution in wet asphalt conditions. Also, if the brakes are wet, you have to brake while driving at low speed to allow them to dry.

13. TRANSMISSION

13.1. CHAIN LUBRICATION

Place the motorcycle on the rear stand, with the engine off and the gearbox in neutral, spray the grease on the chain while turning the rear wheel with your hand continuously and quickly. Lubricate the chain every 3 hours of use and use chain spray.

Use MOTUL C4 CHAIN LUBE FL and MOTUL C1 CHAIN CLEAN.



13.2. CHAIN TENSION CHECK

- Place the motorcycle on the rear stand with the engine off and the gearbox in neutral.
- Check the oscillation in different points of the chain, in the center line between the pinion and the crown. The value must be as shown:



13.3. ADJUSTING CHAIN TENSION

RACING CHAIN TENSIONER



- Place the motorcycle on the rear stand with the engine off and the gearbox in neutral.
 - Loosen the rear wheel pivot.
 - After loosening the locking nut, turn the adjusting screws until the correct chain tension is obtained. Screw in the screws to tighten the chain, unscrew the screws and push the rear wheel forward to loosen the chain.
 - Check the alignment of the rear wheel pivot by verifying that the position of the chain tensioners is the same on both sides with reference to the stampings.
- Hold the adjustment screw firmly and tighten the nut.
 - Tighten the rear wheel pivot nut (tightening torque 60 Nm).

STANDARD CHAIN TENSIONER (only mod.GP-0)

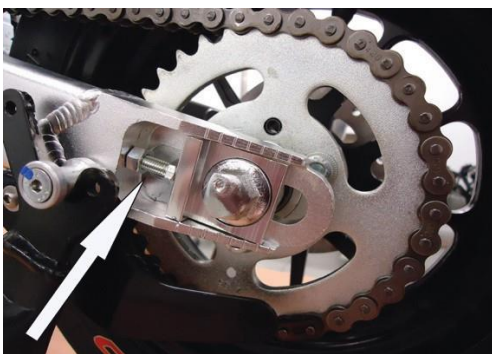

- Place the motorcycle on the rear stand with the engine off and the gearbox in neutral.
 - Loosen the rear wheel pivot
 - After loosening the locking nut, turn the adjusting screws until the correct chain tension is obtained. Unscrew the screws to tighten the chain, screw in the screws and push the rear wheel forward to loosen the chain.
 - Check the alignment of the rear wheel pivot by verifying that the position of the chain tensioners is the same on both sides with reference to the stampings.
- Hold the adjustment screw firmly and tighten the nut.
 - Tighten the rear wheel pivot nut (tightening torque 60 Nm).

13.4. PINION / SPROCKET RATIO TABLE mod. GP0

RATIO		
17	23	1,35
16	23	1,44
17	25	1,47
15	23	1,53
16	25	1,56
17	27	1,59
14	23	1,64
17	28	1,65
15	25	1,67
16	27	1,69
17	29	1,71
16	28	1,75
17	30	1,76
13	23	1,77
14	25	1,79
15	27	1,80
16	29	1,81
17	31	1,82
15	28	1,87
16	30	1,88
17	32	1,88
13	25	1,92
14	27	1,93
15	29	1,93
16	31	1,94
17	33	1,94
14	28	2,00
15	30	2,00
16	32	2,00
17	34	2,00
17	35	2,06
16	33	2,06
15	31	2,07
14	29	2,07
13	27	2,08
17	36	2,12
16	34	2,13
15	32	2,13

RATIO		
14	30	2,14
13	28	2,15
17	37	2,18
16	35	2,19
15	33	2,20
14	31	2,21
13	29	2,23
17	38	2,24
16	36	2,25
15	34	2,27
14	32	2,29
17	39	2,29
13	30	2,31
16	37	2,31
15	35	2,33
14	33	2,36
16	38	2,38
13	31	2,38
15	36	2,40
14	34	2,43
16	39	2,44
13	32	2,46
15	37	2,47
14	35	2,50
15	38	2,53
13	33	2,54
14	36	2,57
15	39	2,60
13	34	2,62
14	37	2,64
13	35	2,69
14	38	2,71
13	36	2,77
14	39	2,79
13	37	2,85
13	38	2,92
13	39	3,00

Stock Ratio



13.5. PINION / SPROCKET RATIO TABLE mod GP2



RATIO		
17	28	1,65
17	29	1,71
16	28	1,75
17	30	1,76
16	29	1,81
15	28	1,87
16	30	1,88
17	32	1,88
15	29	1,93
14	28	2,00
15	30	2,00
16	32	2,00
17	34	2,00
17	35	2,06
14	29	2,07
17	36	2,12
16	34	2,13
15	32	2,13
14	30	2,14
13	28	2,15
17	37	2,18
16	35	2,19
13	29	2,23
16	36	2,25
15	34	2,27
14	32	2,29
13	30	2,31
16	37	2,31
15	35	2,33
15	36	2,40
14	34	2,43
13	32	2,46
15	37	2,47
14	35	2,50
14	36	2,57
13	34	2,62
14	37	2,64
13	35	2,69
13	36	2,77
13	37	2,85

Stock ratio

190 DAYTONA	110 A	160 4S



14. SUSPENSIONS

14.1. REAR SHOCK ABSORBER

The rear shock absorber is adjustable in length, spring preload, hydraulic compression and rebound. (length adjustment on the frame). Many spring are available: the softest spring (K140) is recommended for pilots weighing less than 50Kg while the stiffest one (K175) is recommended for pilots weighing more than 75Kg (as an option). The standard one has K160.

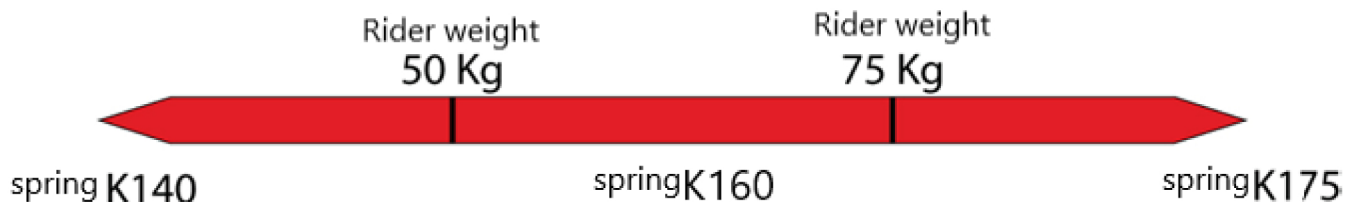

	Spring free length	K140: 135mm K160: 135mm K175: 130mm
GP-0	1 Spring pre-load	K140: 8mm K160: 7mm K175: 3mm
	2 Hydraulic compression	open 6 click from fully closed
	3 Hydraulic extension	open 5 click from fully closed
GP-2	1 Spring pre-load	K140: 10mm K160: 10mm K175: 5mm
	2 Hydraulic compression	open 8 click from fully closed
	3 Hydraulic extension	open 9 click from fully closed

14.2. ADJUSTABLE PRING PRE-LOAD KIT FOR FRONT FORK



The spring preload can be set by acting on the appropriate adjusters; screwing in to increase the preload or unscrewing to decrease it.

Standard regulation: 5 turns.

A softer spring (K6) is available (as an optional) and it's recommended for pilots weighing less than 50Kg. The standard springs are K 7/7.

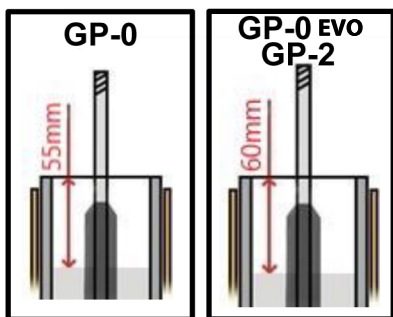
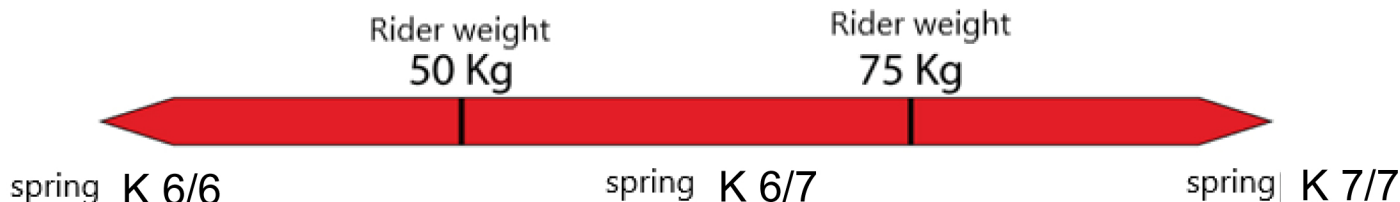

Before proceeding with the replacement of the fork springs, it is necessary to check the oil level inside the stem.

Then you have to gently remove the spring, trying to lose as less oil as possible and perform the measurement indicated in the image.

If necessary, restore the oil level.

Is recommended to use the specific fork oil: **MOTUL FORK OIL FL SAE 10W** 

14.3. REAR SHOCK ABSORBER OHLINS (OPTIONAL)

The OHLINS rear shock absorber is adjustable in spring preload and hydraulic compression & rebound. (length adjustment on the frame)

Two types of springs are available: with K160 for pilots weighing of more than 75kg and a softer one with K140 recommended for pilots weighing less than 50Kg.

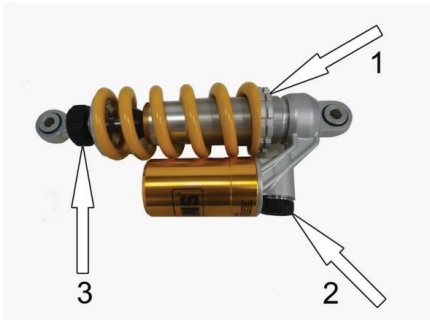
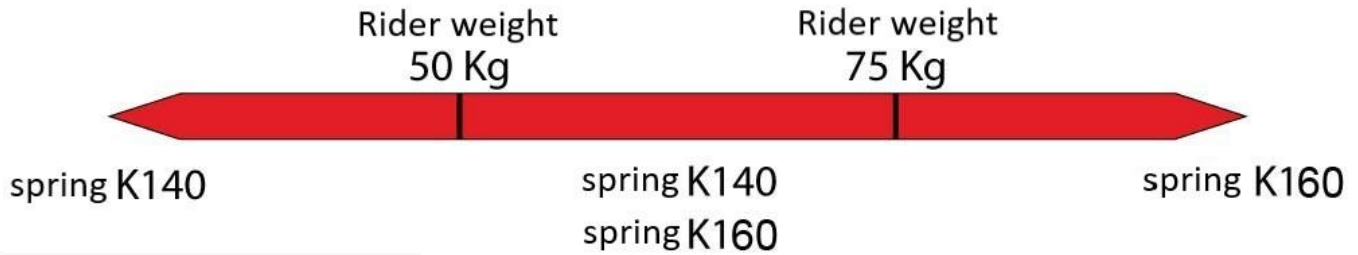

	Spring free length	K140: 145mm K160: 145mm
GP-0	1 Spring preload	K140: 8mm K160: 7mm
GP-2	1 Spring preload	K140: 10mm K160: 10mm
	2 idraulica in compressione	aperto 8 click da fully closed
	3 idraulica in estensione	aperto 9 click da fully closed

14.4. MUPO FRONT FORK (OPTIONAL)



The spring preload can be set by acting on the appropriate adjusters; screwing in to increase the preload or unscrewing to decrease it.

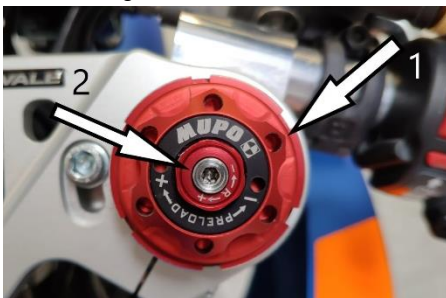

1	Spring preload	5.5 turns = 11 clicks (from fully open)
2	Hydraulic compression (C engraved on the cap)	28 clicks (from fully closed)
2	Hydraulic extension (R engraved on the cap)	15 clicks (from fully closed)

The fork in standard configuration (for riders weighing more than 75 kg) has a spring of K7.5 stiffness (on the right sheath) and a spring of K6.5 stiffness. It's possible to **replace only the right spring**: with a softer one with K6.5 for pilots weighing between 50kg and 75kg or with K5.5 for pilots weighing less than 50kg.

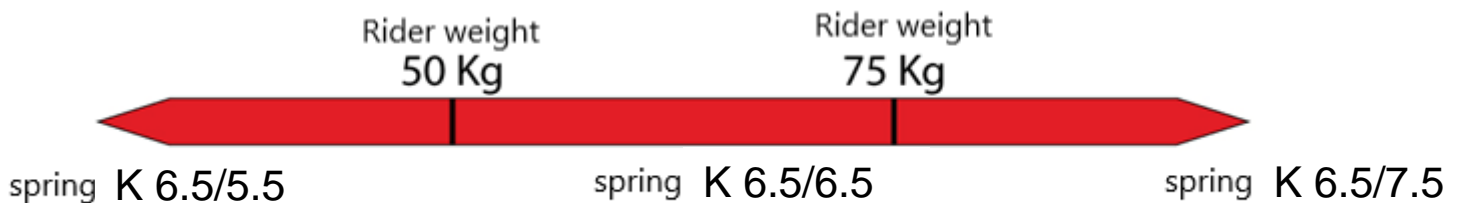

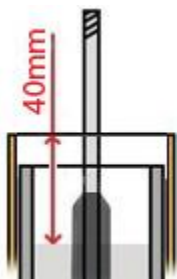

Before proceeding with the replacement of the fork springs, it is necessary to check the oil level inside the stem.

You will have to gently remove the spring, trying to lose as less oil as possible and then perform the measurement indicated in the image. (oil level 40mm from the fork sheath).

If necessary, restore the oil level.

It's recommended to use the specific fork oil: MOTUL SAE 5W.



15. DASHBOARD ALFANO (optional)

The **Alfano 6** dashboard has an acquisition system capable of recording:



- Engine RPM.
- Velocity.
- Lap times.
- Position inside the track.

It is possible to set LEDs to display the rotation speed at which changing gear. The **Alfano 6** dashboard is equipped with a backlit display in order to be able to view the data while riding. Data can also be downloaded via Bluetooth and viewed on PCs and Smartphones

using the software created by **ALFANO** and downloadable from: <https://www.alfano.com/it/software/> or from the App Store for Android and iOS systems.

NOTE: For more information, refer to the instruction manual supplied with the dashboard.

16. FLUIDS and LUBRIFICANTS



Type	Brand	Description
ENGINE OIL	MOTUL	300V 4T Factory line 10w40
FORK OIL (d.33 fork)	MOTUL	Fork Oil Factory Line Medium SAE 10W
FORK OIL (d.38 fork)	MOTUL	Fork Oil Factory Line Light SAE 5W
BRAKE FLUID	MOTUL	Racing Brake Fluid 660 Factory Line
CHAIN CLEANER	MOTUL	C1 Chain Clean
CHAIN LUBE	MOTUL	C4 Chain Lube Factory Line

Ohvale recommends Motul.

17. TRIM AND SETTINGS

17.1. SAG REGULATION

In order to obtain a correct behavior of the motorcycle during the use, it is necessary to check that the suspensions are properly calibrated with respect to the rider's weight. To verify this, perform the following steps:

SAG MEASURE

1. Raise the front of the motorcycle so that the front wheel is not touching the ground and the fork is fully extended.
2. Measure the distance between the front wheel pivot and the base of the fork sheath. (F1)
3. Lift the rear of the bike so that the rear wheel does not touch the ground and the shock absorber is fully extended.
4. Measure the distance between the axis of the stand peg and the lower rear frame tube. (R1)
5. Place the motorcycle vertically with the wheels on a flat ground.
6. Repeat the measurements of points 2 and 4 with the rider in the driving position and wearing protective clothing (F2 & R2)

The differences between the measurements made with and without the rider must be respectively equal to:

<u>GP-0</u>	<u>GP-2</u>
FRONT (F1-F2) = 11 ÷ 15mm. REAR (F1-F2) = 18 ÷ 22mm.	FRONT (F1-F2) = 14 ÷ 18 mm. REAR (F1-F2) = 17 ÷ 21 mm.

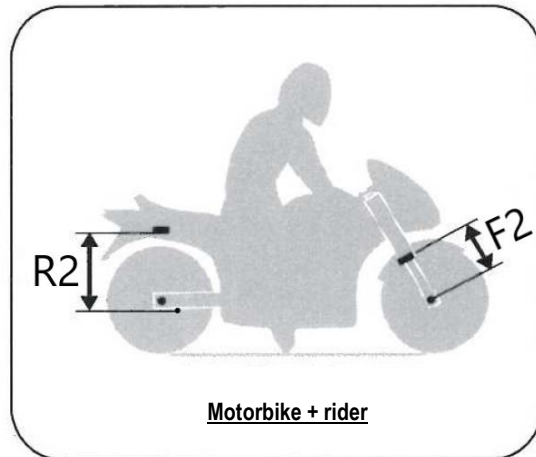
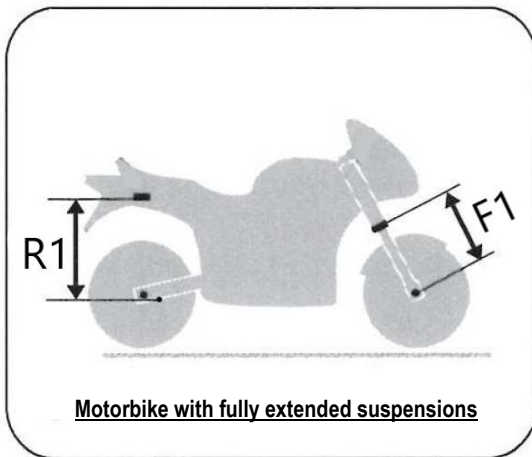

SUSPENSION SETTING

If the measurements are not within the ranges shown, it will be necessary to act on the suspension preloads.

- **FRONT SUSPENSION:** Act on the spring preload adjusters, screwing them in if the sag measurement is higher than the indicated range. On the contrary, unscrew the register if the SAG is lower than the indicated range.
- **REAR SUSPENSION:** Act on the spring preload adjustment ring nut by screwing it in case the sag measurement is higher than the indicated range. On the contrary, unscrew the ring nut if the SAG is lower than the indicated range.

In the event that the SAG measures do not fall within the ranges indicated through the use of the registers and the ring nut, it will be necessary to replace the springs with a harder or softer set (see SUSPENSION chapter).

18. PERIODIC MAINTENANCE

	After running in	Every 10 h	Every 20 h	Every 40 h	If necessary	NOTES
ENGINE OIL	S	S				Check the level after race.
ENGINE OIL FILTER	S	S				
INTERNAL NET OIL FILTER			P			
VALVE CLEARANCE	C	C				Check with cold engine.
VALVE SPRINGS				C	S	Check length.
CAM SHAFT				C	S	Inspect cam surfaces.
SHIFT-GEARS-SHIFT FORKS-DESMO				C	S	Check the wear of gears and forks.
PISTON				S		
PISTON RINGS				S		
PISTON PIN				S		
ENGINE HEAD				C+P	S	Check valve seats and clean carbon deposits. Change gasket.
CYLINDER				C	S	Inspect for scratches. Check wear.
ENGINE SHAFT				C	S	Check connecting rod and bearings.
CLUTCH		C			S	Inspect clutch bell, discs and clutch springs.
TIMING CHAIN - GEARS			C	S		Check wear of chain and teeth.
FLYWHEEL NUT	C		C		S	Maximum tightening torque 50Nm (35 lbft).
CARTER				C		
SPARK PLUG	C	S			S	
AIR FILTER		P	S		S	Use air filter oil or equivalent.
CARBURETOR		C+P				
FUEL SYSTEM		C				Check pipes, gas tap and carburetor.
OIL RADIATOR	C	C			S	Check for leaks and wear of pipes.
BRAKE FLUID	C	C	S			Check level.
BRAKE PADS		C			S	Check wear.
BRAKE SYSTEM		C			S	Check brake discs and hoses. Revise if necessary.
TIGHTENING BOLTS & NUTS	C	C				See table "TIGHTENING TORQUES".
FRONT FORK			C			Check for oil leaks.
RECOVERY TANK					C	Check and empty if necessary.
WHEELS AND TYRES	IN CASE OF TIRES REPLACEMENT ALWAYS CHECK THE SLIDING AND CLEARANCE OF THE BEARINGS.					
STEERING BEARINGS	C		C			Lubricate and if necessary register every hour of use.
TRANSMISSION CHAIN	L+R		S			
PINION & SPROCKET			C		S	Check teeth wear.
CLUTCH COMMAND	C	C			S	
THROTTLE COMMAND		C				



C: CONTROL AND CLEAN, REGISTER, LUBRICATE --

L: LUBRICATE -- **P:** CLEAN -- **S:** SUBSTITUTE -- **R:** REGISTER

19. TIGHTENING TORQUES

	Q.ty	Thread	Nm	Kgm	Lb ft	Notes
Front wheel pivot	1	(*)	60	6	44	(*) M12 mod. GP-0 M14x1,5 mod. GP-2
Rear wheel pivot	1	M14x1,5	60	6	44	
Swingarm pivot	1	M12	60	6	44	
Steering ring nut – ball bearing	1	M25x1,5	10	1	7,5	
Steering ring nut – tapered bearing	1	M25x1,5	15	1,5	11	
Steering pivot screw	1	M16x1,5	40	4	29,5	
Inferior steering plate screws	4	M6	10	1	7,5	
Superior steering plate screws	2	M8	15	1,5	11	
Half-handlebar bracelet screw	2	M8	15	1,5	11	
Half-handlebar screw	2	M8	22	2,2	16,5	
Brake disc screws	6	M8	20	2	15	Medium thread lock
Brake calipers screws (Formula)	4	M8	25	2,5	18,5	
Brake calipers screws (J.Juan)	2	M10	45	4,5	33,2	
Sprocket stud bolts	3	M8 GP-0 M10 GP-2	25	2,5	18,5	Strong thread lock
Sprocket fixing nuts	3	M8 GP-0 M10 GP-2	25	2,5	18,5	
Gear/brake lever peg screws	2	M8	15	1,5	11	Medium thread lock
Footrest protection screws	2	M6	8	0,8	6	Medium thread lock
Footrest support fixing screws	4	M8	25	2,5	18,5	Medium thread lock
Shock absorber support fix. nut	1	M14x1,5	60	6	44	
Engine support fixing nuts	2	M8	25	2,5	18,5	160-4s
Engine support fixing nuts	2	M7	16	1,6	12	110-A – 110-4s
Front engine support stud bolts 190/212	2	M8	15	1,5	11	Strong thread lock
Front support engine nuts 190/212	2	M8	25	2,5	18,5	190 - 212
Engine fixing screws	2	M8(10.9)	35	3,5	25,5	
Spark plug	1	M10x1	14	1,4	10,5	
Oil drain screw	1	M12x1,5	24	2,4	18	
Kick lever fixing screw	1	M8	25	2,5	18,5	
Fairing / front fender fixing screws	16	M5	3	0,3	2	
Fairing / rear fender fixing screws	6	M6	5	0,5	3,5	
Fixing tank cover screws	2/3	M6	8	0,8	6	

20. APPROVED TIRES for mod. GP-0

	front <i>Diablo SBK</i> 100/80 10 - slick compound SC1 rear <i>Diablo SBK</i> 120/80 10 - slick compound SC1
	front <i>Diablo RAIN</i> 100/80 10 - rain (NO tyrewarmers) rear <i>Diablo RAIN</i> 120/80 10 - rain (NO tyrewarmers)

COLD TIRE PREASSURE for mod. GP-0





Front 1.2/1.4 bar (120/140 kPa)

RAIN Front 1.6 bar (130 kPa)

Rear 1.1/1.3 bar (110/130 kPa)

RAIN Rear 1.4 bar (140 kPa)

21. APPROVED TIRES for mod. GP-2

	front <i>Diablo Scooter</i> 100/90 12 carved <i>Diablo SBK</i> 100/90 12 slick – compound SC1 rear <i>Diablo Scooter</i> 120/80 12 carved <i>Diablo SBK</i> 120/80 12 slick – compound SC1
	front 100/90 12 slick – compound S rear 120/80 12 slick – compound S
	front <i>TT93F GP</i> 100/90 12 carved – compound STD rear <i>TT93 GP</i> 120/80 12 carved – compound S
	front <i>MC 35</i> 100/90 12 carved – compound S rear <i>MC 35</i> 120/80 12 carved – compound S

COLD TIRE PREASSURE for mod. GP-2

Front 1.2/1.4 bar (120/140 kPa)

Rear 1.1/1.3 bar (110/130 kPa)

Driving with excessively worn or improperly inflated tires can cause crashes resulting in death or serious injury. It is therefore recommended to follow the instructions contained in this manual with reference to tire inflation and maintenance.



The use of incorrect tires on the vehicle can affect control, stability, safety and can cause accidents resulting in serious or fatal injuries. It is therefore recommended to use only tires of the type and size indicated in this manual.



In case of rain or on wet track it's recommend to use rain tires. Using a type of tire that is not suitable for the road surface conditions can cause accidents resulting in serious or fatal injuries.

22. TIREWARMERS



To ensure excellent grip of the tires from the first laps, the use of ORIGINAL OHVALE TIRE WARMERS is recommended.

See instructions regarding use, cleaning and precautions, contained in the user manual supplied with the tirewarmers.

NOT USE Tirewarmers with RAIN tires.

INDEX

1.	WARNINGS	3
2.	HALF-HANDLEBAR POSITION.....	4
3.	CHOKE – STARTING THE ENGINE	4
3.1.	HANDLEBAR CHOKE COMMAND.....	4
3.2.	CARBURETOR CHOKE COMMAND.....	4
3.3.	ENGINE START mod. 110 AUTOMATIC.....	5
3.4.	ENGINE START with KICK STARTER.....	5
4.	SHIFT LEVER.....	6
4.1.	REVERSE SHIFT LEVER	6
5.	REFUELING	6
6.	ENGINE RUNNING-IN.....	7
7.	ENGINE OIL	7
7.1.	OIL QUANTITY (with engine completely empty).....	7
7.2.	ENGINE OIL LEVEL CHECK	7
7.3.	VALVE CLEARANCE.....	Errore. Il segnalibro non è definito.
8.	BATTERY (VERSIONE 110 A).....	9
8.1.	WARNINGS	9
9.	BRAKES.....	10
9.1.	BRAKE FLUID LEVEL CHECK.....	10
9.2.	BRAKE LEVER REGULATION – JJUAN BRAKE SYSTEM.....	10
9.3.	BRAKE PADS RUNNING-IN	10
10.	TRANSMISSION	11
10.1.	CHAIN LUBRICATION	11
10.2.	CHAIN TENSION CHECK	11
10.3.	ADJUSTING CHAIN TENSION	11
10.4.	PINION / SPROCKET RATIO TABLE mod. GP0	12
10.5.	PINION / SPROCKET RATIO TABLE mod GP2	13
11.	SUSPENSIONS	14
11.1.	REAR SHOCK ABSORBER.....	14
11.2.	ADJUSTABLE PRING PRE-LOAD KIT FOR FRONT FORK	14
11.3.	REAR SHOCK ABSORBER OHLINS (OPTIONAL)	15
11.4.	ANDREANI FORK CARTRIDGES (OPTIONAL only for mod. GP-0)	Errore. Il segnalibro non è definito.
11.5.	MUPO FRONT FORK (OPTIONAL)	15
12.	DASHBOARD ALFANO (optional).....	16
13.	TRIM AND SETTINGS.....	17
13.1.	SAG REGULATION.....	17
14.	PERIODIC MAINTENANCE	18
15.	TIGHTENING TORQUES	19
16.	APPROVED TIRES for mod. GP-0.....	20
17.	APPROVED TIRES for mod. GP-2.....	20
17.1.	TIREWARMERS	20



OHVALE srl - Via Evangelista Torricelli, 25 - 31021 Mogliano Veneto (TV) Tel. +39.041.5903584 - Fax
+39.041.5938277 - info@ohvale.com

P.IVA E C.F. 04604340267